

## **PART 5**

# **Consignment procedures**



## CHAPTER 5.1

### GENERAL PROVISIONS

#### 5.1.1 Application and general provisions

This Part sets forth the provisions for dangerous goods consignments relative to marking, labelling, and documentation, and, where appropriate, authorization of consignments and advance notifications.

#### 5.1.2 Use of overpacks

##### 5.1.2.1 (a) An overpack shall be:

- (i) marked with the word "OVERPACK"; and
- (ii) marked with the UN number preceded by the letters "UN", and be labelled as required for packages in 5.2.2, for each item of dangerous goods contained in the overpack,

unless the markings and the labels representative of all dangerous goods contained in the overpack are visible. If the same marking or the same label is required for different packages, it only needs to be applied once.

The marking of the word "OVERPACK", which shall be readily visible and legible, shall be in an official language of the country of origin and also, if that language is not English, French or German, in English, French or German, unless agreements, if any, concluded between the countries concerned in the transport operation provide otherwise.

##### (b) Orientation arrows illustrated in 5.2.1.9 shall be displayed on two opposite sides of the following overpacks:

- (i) overpacks containing packages which shall be marked in accordance with 5.2.1.9.1, unless the marking remains visible, and
- (ii) overpacks containing liquids in packages which need not be marked in accordance with 5.2.1.9.2, unless the closures remain visible.

##### 5.1.2.2 Each package of dangerous goods contained in an overpack shall comply with all applicable provisions of ADR. The intended function of each package shall not be impaired by the overpack.

##### 5.1.2.3 Each package bearing package orientation markings as prescribed in 5.2.1.9 and which is overpacked or placed in a large packaging shall be oriented in accordance with such markings.

##### 5.1.2.4 The prohibitions on mixed loading also apply to these overpacks.

### **5.1.3 Empty uncleaned packagings (including IBCs and large packagings), tanks, vehicles and containers for carriage in bulk**

5.1.3.1 Empty uncleaned packagings (including IBCs and large packagings), tanks (including tank-vehicles, battery-vehicles, demountable tanks, portable tanks, tank-containers, MEGCs), vehicles and containers for carriage in bulk having contained dangerous goods of the different classes other than Class 7, shall be marked and labelled as if they were full.

*NOTE: For documentation, see Chapter 5.4.*

5.1.3.2 Tanks and IBCs used for the carriage of radioactive material shall not be used for the storage or carriage of other goods unless decontaminated below the level of 0.4 Bq/cm<sup>2</sup> for beta and gamma emitters and low toxicity alpha emitters and 0.04 Bq/cm<sup>2</sup> for all other alpha emitters.

### **5.1.4 Mixed packing**

When two or more dangerous goods are packed within the same outer packaging, the package shall be labelled and marked as required for each substance or article. If the same label is required for different goods, it only needs to be applied once.

### **5.1.5 General provisions for Class 7**

#### **5.1.5.1 Requirements before shipments**

##### *5.1.5.1.1 Requirements before the first shipment of a package*

Before the first shipment of any package, the following requirements shall be fulfilled:

- (a) If the design pressure of the containment system exceeds 35 kPa (gauge), it shall be ensured that the containment system of each package conforms to the approved design requirements relating to the capability of that system to maintain its integrity under that pressure;
- (b) For each Type B(U), Type B(M) and Type C package and for each package containing fissile material, it shall be ensured that the effectiveness of its shielding and containment and, where necessary, the heat transfer characteristics and the effectiveness of the confinement system, are within the limits applicable to or specified for the approved design;
- (c) For packages containing fissile material, where, in order to comply with the requirements of 6.4.11.1, neutron poisons are specifically included as components of the package, checks shall be performed to confirm the presence and distribution of those neutron poisons.

##### *5.1.5.1.2 Requirements before each shipment of a package*

Before each shipment of any package, the following requirements shall be fulfilled:

- (a) For any package it shall be ensured that all the requirements specified in the relevant provisions of ADR have been satisfied;
- (b) It shall be ensured that lifting attachments which do not meet the requirements of 6.4.2.2 have been removed or otherwise rendered incapable of being used for lifting the package, in accordance with 6.4.2.3;

- (c) For each package requiring competent authority approval, it shall be ensured that all the requirements specified in the approval certificates have been satisfied;
- (d) Each Type B(U), Type B(M) and Type C package shall be held until equilibrium conditions have been approached closely enough to demonstrate compliance with the requirements for temperature and pressure unless an exemption from these requirements has received unilateral approval;
- (e) For each Type B(U), Type B(M) and Type C package, it shall be ensured by inspection and/or appropriate tests that all closures, valves, and other openings of the containment system through which the radioactive contents might escape are properly closed and, where appropriate, sealed in the manner for which the demonstrations of compliance with the requirements of 6.4.8.8 were made;
- (f) For each special form radioactive material, it shall be ensured that all the requirements specified in the approval certificate and the relevant provisions of ADR have been satisfied;
- (g) For packages containing fissile material the measurement specified in 6.4.11.4 (b) and the tests to demonstrate closure of each package as specified in 6.4.11.7 shall be performed where applicable;
- (h) For each low dispersible radioactive material, it shall be ensured that all the requirements specified in the approval certificate and the relevant provisions of ADR have been satisfied.

## **5.1.5.2** *Approval of shipments and notification*

### **5.1.5.2.1** *General*

In addition to the approval for package designs described in Chapter 6.4, multilateral shipment approval is also required in certain circumstances (5.1.5.2.2 and 5.1.5.2.3). In some circumstances it is also necessary to notify competent authorities of a shipment (5.1.5.2.4).

### **5.1.5.2.2** *Shipment approvals*

Multilateral approval shall be required for:

- (a) the shipment of Type B(M) packages not conforming with the requirements of 6.4.7.5 or designed to allow controlled intermittent venting;
- (b) the shipment of Type B(M) packages containing radioactive material with an activity greater than 3000 A<sub>1</sub> or 3000 A<sub>2</sub>, as appropriate, or 1000 TBq, whichever is the lower; and
- (c) The shipment of packages containing fissile materials if the sum of the criticality safety indexes of the packages in a single vehicle or container exceeds 50;

except that a competent authority may authorize carriage into or through its country without shipment approval, by a specific provision in its design approval (see 5.1.5.3.1).

### 5.1.5.2.3 *Shipment approval by special arrangement*

Provisions may be approved by a competent authority under which a consignment, which does not satisfy all of the applicable requirements of ADR may be carried under special arrangement (see 1.7.4).

### 5.1.5.2.4 *Notifications*

Notification to competent authorities is required as follows:

- (a) Before the first shipment of any package requiring competent authority approval, the consignor shall ensure that copies of each applicable competent authority certificate applying to that package design have been submitted to the competent authority of each country through or into which the consignment is to be carried. The consignor is not required to await an acknowledgement from the competent authority, nor is the competent authority required to make such acknowledgement of receipt of the certificate;
- (b) For each of the following types of shipments:
  - (i) Type C packages containing radioactive material with an activity greater than 3000 A<sub>1</sub> or 3000 A<sub>2</sub>, as appropriate, or 1000 TBq, whichever is the lower;
  - (ii) Type B(U) packages containing radioactive material with an activity greater than 3000 A<sub>1</sub> or 3000 A<sub>2</sub>, as appropriate, or 1000 TBq, whichever is the lower;
  - (iii) Type B(M) packages;
  - (iv) Shipment under special arrangement;

The consignor shall notify the competent authority of each country through or into which the consignment is to be carried. This notification shall be in the hands of each competent authority prior to the commencement of the shipment, and preferably at least 7 days in advance;

- (c) The consignor is not required to send a separate notification if the required information has been included in the application for shipment approval;
- (d) The consignment notification shall include:
  - (i) sufficient information to enable the identification of the package or packages including all applicable certificate numbers and identification marks;
  - (ii) information on the date of shipment, the expected date of arrival and proposed routing;
  - (iii) the name(s) of the radioactive material(s) or nuclide(s);
  - (iv) descriptions of the physical and chemical forms of the radioactive material, or whether it is special form radioactive material or low dispersible radioactive material; and
  - (v) the maximum activity of the radioactive contents during carriage expressed in becquerels (Bq) with an appropriate SI prefix symbol (see 1.2.2.1). For fissile material, the mass of fissile material in grams (g), or multiples thereof, may be used in place of activity.

### **5.1.5.3** *Certificates issued by the competent authority*

5.1.5.3.1 Certificates issued by the competent authority are required for the following:

- (a) Designs for:
  - (i) special form radioactive material;
  - (ii) low dispersible radioactive material;
  - (iii) packages containing 0.1 kg or more of uranium hexafluoride;
  - (iv) all packages containing fissile material unless excepted by 6.4.11.2;
  - (v) Type B(U) packages and Type B(M) packages;
  - (vi) Type C packages;
- (b) Special arrangements;
- (c) Certain shipments (see 5.1.5.2.2).

The certificates shall confirm that the applicable requirements are met, and for design approvals shall attribute to the design an identification mark.

The package design and shipment approval certificates may be combined into a single certificate.

Certificates and applications for these certificates shall be in accordance with the requirements in 6.4.23.

5.1.5.3.2 The consignor shall be in possession of a copy of each applicable certificate. The consignor shall also have a copy of any instructions with regard to the proper closing of the package and any preparation for shipment before making any shipment under the terms of the certificates.

5.1.5.3.3 For package designs where a competent authority issued certificate is not required, the consignor shall, on request, make available for inspection by the competent authority, documentary evidence of the compliance of the package design with all the applicable requirements.

### **5.1.5.4** *Summary of approval and prior notification requirements*

**NOTE 1:** *Before first shipment of any package requiring competent authority approval of the design, the consignor shall ensure that a copy of the approval certificate for that design has been submitted to the competent authority of each country en route (see 5.1.5.2.4 (a)).*

**NOTE 2:** *Notification required if contents exceed  $3 \times 10^3 A_1$ , or  $3 \times 10^3 A_2$ , or 1000 TBq; (see 5.1.5.2.4 (b)).*

**NOTE 3:** *Multilateral approval of shipment required if contents exceed  $3 \times 10^3 A_1$ , or  $3 \times 10^3 A_2$ , or 1000 TBq, or if controlled intermittent venting is allowed (see 5.1.5.2).*

**NOTE 4:** *See approval and prior notification provisions for the applicable package for carrying this material.*

Subject	UN Number	Competent Authority approval required		Consignor required to notify the competent authorities of the country of origin and of the countries en route <sup>a</sup> before each shipment	Reference
		Country of origin	Countries en route <sup>a</sup>		
Calculation of unlisted A <sub>1</sub> and A <sub>2</sub> values	-	Yes	Yes	No	---
Excepted packages - package design - shipment	2908, 2909, 2910, 2911	No No	No No	No No	---
LSA material <sup>b</sup> and SCO <sup>b</sup> Industrial packages types 1, 2 or 3, non fissile and fissile excepted	2912, 2913, 3321, 3322				---
- package design - shipment		No No	No No	No No	
Type A packages <sup>b</sup> , non fissile and fissile excepted - package design - shipment	2915, 3332	No No	No No	No No	--
Type B(U) packages <sup>b</sup> , non fissile and fissile excepted - package design - shipment	2916	Yes No	No No	See Note 1 See Note 2	5.1.5.2.4 (b), 5.1.5.3.1 (a), 6.4.22.2
Type B(M) packages <sup>b</sup> , non fissile and fissile excepted - package design - shipment	2917	Yes See Note 3	Yes See Note 3	No Yes	5.1.5.2.4 (b), 5.1.5.3.1 (a), 5.1.5.2.2, 6.4.22.3
Type C packages <sup>b</sup> , non fissile and fissile excepted - package design - shipment	3323	Yes No	No No	See Note 1 See Note 2	5.1.5.2.4 (b), 5.1.5.3.1 (a), 6.4.22.2
Packages for fissile material - package design - shipment : - sum of criticality safety indexes not more than 50 - sum of criticality safety indexes greater than 50	2977, 3324, 3325, 3326, 3327, 3328, 3329, 3330, 3331, 3333	Yes <sup>c</sup>  No <sup>d</sup>  Yes	Yes <sup>c</sup>  No <sup>d</sup>  Yes	No  See Note 2  See Note 2	5.1.5.3.1 (a), 5.1.5.2.2, 6.4.22.4, 6.4.22.5
Special form radioactive material - design - shipment	- See Note 4	Yes See Note 4	No See Note 4	No See Note 4	1.6.6.3, 5.1.5.3.1 (a) 6.4.22.5

<sup>a</sup> Countries from, through or into which the consignment is carried.

<sup>b</sup> If the radioactive contents are fissile material which is not excepted from the provisions for packages containing fissile material, then the provisions for fissile material packages apply (see 6.4.11).

<sup>c</sup> Designs of packages for fissile material may also require approval in respect of one of the other items in the table.

<sup>d</sup> Shipments may, however, require approval in respect of one of the other items in the table.



Subject	UN Number	Competent Authority approval required		Consignor required to notify the competent authorities of the country of origin and of the countries en route <sup>a</sup> before each shipment	Reference
		Country of origin	Countries en route <sup>a</sup>		
Low dispersable radioactive material - design - shipment	- See Note 4	Yes See Note 4	No See Note 4	No See Note 4	5.1.5.3.1 (a), 6.4.22.3
Packages containing 0.1 kg or more of uranium hexafluoride - design - shipment	- See Note 4	Yes See Note 4	No See Note 4	No See Note 4	5.1.5.3.1 (a), 6.4.22.1
Special Arrangement - shipment	2919, 3331	Yes	Yes	Yes	1.7.4.2, 5.1.5.3.1 (b), 5.1.5.2.4 (b)
Approved packages designs subjected to transitional measures	-	See 1.6.6	See 1.6.6	See Note 1	1.6.6.1, 1.6.6.2, 5.1.5.2.4 (b), 5.1.5.3.1 (a), 5.1.5.2.2.

<sup>a</sup> Countries from, through or into which the consignment is carried.



## CHAPTER 5.2

### MARKING AND LABELLING

#### 5.2.1 Marking of packages

*NOTE: For markings related to the construction, testing and approval of packagings, large packagings, gas receptacles and IBCs, see Part 6.*

5.2.1.1 Unless provided otherwise in ADR, the UN number corresponding to the dangerous goods contained, preceded by the letters "UN" shall be clearly and durably marked on each package. In the case of unpackaged articles the marking shall be displayed on the article, on its cradle or on its handling, storage or launching device.

5.2.1.2 All package markings required by this Chapter:

- (a) shall be readily visible and legible;
- (b) shall be able to withstand open weather exposure without a substantial reduction in effectiveness.

5.2.1.3 Salvage packagings shall additionally be marked with the word "**SALVAGE**".

5.2.1.4 Intermediate bulk containers of more than 450 litres capacity and large packagings shall be marked on two opposite sides.

#### 5.2.1.5 *Additional provisions for goods of Class 1*

For goods of Class 1, packages shall, in addition, bear the proper shipping name as determined in accordance with 3.1.2. The marking, which shall be clearly legible and indelible, shall be in an official language of the country of origin and also, if that language is not English, French or German, in English, French or German unless any agreements concluded between the countries concerned in the transport operation provide otherwise.

#### 5.2.1.6 *Additional provisions for goods of Class 2*

Refillable receptacles shall bear the following particulars in clearly legible and durable characters:

- (a) the UN number and the proper shipping name of the gas or mixture of gases, as determined in accordance with 3.1.2.  
In the case of gases classified under an N.O.S. entry, only the technical name<sup>1</sup> of the gas has to be indicated in addition to the UN number.  
In the case of mixtures, not more than the two constituents which most predominantly contribute to the hazards have to be indicated;

---

<sup>1</sup> *Instead of the technical name the use of one of the following names is permitted:*

- *for UN No. 1078 refrigerant gas, n.o.s.: mixture F1, mixture F2, mixture F3;*
- *for UN No. 1060 methylacetylene and propadiene mixtures, stabilized: mixture P1, mixture P2;*
- *for UN No. 1965 hydrocarbon gas mixture, liquefied, n.o.s.: mixture A or butane, mixture A01 or butane, mixture A02 or butane, mixture A0 or butane, mixture A1, mixture B1, mixture B2, mixture B, mixture C or propane;*
- *for UN No. 1010 Butadienes, stabilized: 1,2-Butadiene, stabilized, 1,3-Butadiene, stabilized.*

- (b) for compressed gases filled by mass and for liquefied gases, either the maximum filling mass and the tare of the receptacle with fittings and accessories as fitted at the time of filling, or the gross mass;
- (c) the date (year) of the next periodic inspection.

These marks can either be engraved or indicated on a durable information disk or label attached on the receptacle or indicated by an adherent and clearly visible marking such as by printing or by any equivalent process.

**NOTE 1:** See also 6.2.1.7.

**NOTE 2:** For non refillable receptacles, see 6.2.1.8.

### **5.2.1.7 Special marking provisions for goods of Class 7**

- 5.2.1.7.1 Each package shall be legibly and durably marked on the outside of the packaging with an identification of either the consignor or consignee, or both.
- 5.2.1.7.2 For each package, other than excepted packages, the UN number preceded by the letters "UN" and the proper shipping name shall be legibly and durably marked on the outside of the packaging. In the case of excepted packages only the UN number, preceded by the letters "UN", is required.
- 5.2.1.7.3 Each package of gross mass exceeding 50 kg shall have its permissible gross mass legibly and durably marked on the outside of the packaging.
- 5.2.1.7.4 Each package which conforms to:
  - (a) a Type IP-1 package, a Type IP-2 package or a Type IP-3 package design shall be legibly and durably marked on the outside of the packaging with "TYPE IP-1", "TYPE IP-2" or "TYPE IP-3" as appropriate;
  - (b) a Type A package design shall be legibly and durably marked on the outside of the packaging with "TYPE A";
  - (c) a Type IP-2 package, a Type IP-3 package or a Type A package design shall be legibly and durably marked on the outside of the packaging with the international vehicle registration code (VRI Code) <sup>2</sup> of the country of origin of design and either the name of the manufacturer or other identification of the packaging specified by the competent authority of the country of origin of design.
- 5.2.1.7.5 Each package which conforms to a design approved by the competent authority shall be legibly and durably marked on the outside of the packaging with:
  - (a) the identification mark allocated to that design by the competent authority;
  - (b) a serial number to uniquely identify each packaging which conforms to that design;
  - (c) in the case of a Type B(U) or Type B(M) package design, with "TYPE B(U)" or "TYPE B(M)"; and
  - (d) in the case of a Type C package design, with "TYPE C".

---

<sup>2</sup> Distinguishing sign for motor vehicles in international traffic prescribed in the Vienna Convention on Road Traffic (1968).

5.2.1.7.6 Each package which conforms to a Type B(U), Type B(M) or Type C package design shall have the outside of the outermost receptacle which is resistant to the effects of fire and water plainly marked by embossing, stamping or other means resistant to the effects of fire and water with the trefoil symbol shown in the figure below.

Basic trefoil symbol with proportions based on a central circle of radius X.  
The minimum allowable size of X shall be 4 mm.

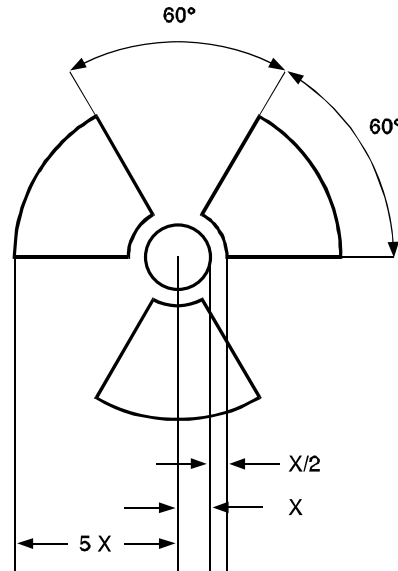

5.2.1.7.7 Where LSA-I or SCO-I material is contained in receptacles or wrapping materials and is carried under exclusive use as permitted by 4.1.9.2.3, the outer surface of these receptacles or wrapping materials may bear the marking "RADIOACTIVE LSA-I" or "RADIOACTIVE SCO-I", as appropriate.

5.2.1.7.8 In case of international carriage of packages requiring competent authority design or shipment approval, for which different approval types apply in the different countries concerned, marking shall be in accordance with the certificate of the country of origin of the design.

5.2.1.8 *(Reserved)*

5.2.1.9 *Orientation arrows*

5.2.1.9.1 Except as provided in 5.2.1.9.2:

- combination packagings having inner packagings containing liquids;
- single packagings fitted with vents; and
- cryogenic receptacles intended for the carriage of refrigerated liquefied gases,

shall be legibly marked with package orientation arrows which are similar to the illustration shown below or with those meeting the specifications of ISO 780:1985. The orientation arrows shall appear on two opposite vertical sides of the package with the arrows pointing in the correct upright direction. They shall be rectangular and of a size that is clearly visible commensurate with the size of the package. Depicting a rectangular border around the arrows is optional.

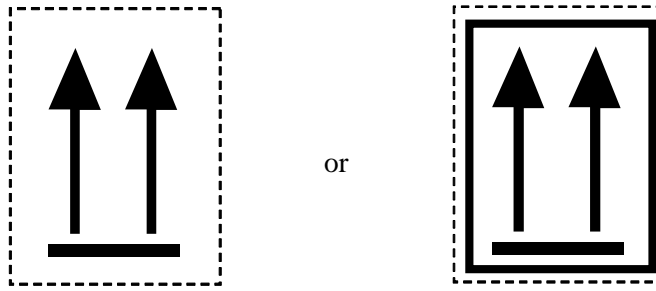

Two black or red arrows on white or suitable contrasting background.  
The rectangular border is optional.

5.2.1.9.2 Orientation arrows are not required on packages containing:

- (a) pressure receptacles except for closed cryogenic receptacles;
- (b) dangerous goods in inner packagings of not more than 120 ml which are prepared with sufficient absorbent material between the inner and outer packagings to completely absorb the liquid contents;
- (c) Class 6.2 infectious substances in primary receptacles of not more than 50 ml;
- (d) Class 7 radioactive material in Type IP-2, IP-3, A, B(U), B(M) or C packages; or
- (e) articles which are leak-tight in all orientations (e.g. alcohol or mercury in thermometers, aerosols, etc.).

5.2.1.9.3 Arrows for purposes other than indicating proper package orientation shall not be displayed on a package marked in accordance with this sub-section.

## 5.2.2 Labelling of packages

### 5.2.2.1 Labelling provisions

5.2.2.1.1 For each article or substance listed in Table A of Chapter 3.2, the labels shown in Column (5) shall be affixed unless otherwise provided for by a special provision in Column (6).

5.2.2.1.2 Indelebile danger markings corresponding exactly to the prescribed models may be used instead of labels.

5.2.2.1.3 to  
5.2.2.1.5 *(Reserved)*

5.2.2.1.6 Except as provided in 5.2.2.1.2, each label shall:

- (a) be affixed to the same surface of the package, if the dimensions of the package allow; for packages of Class 1 and 7, near the mark indicating the proper shipping name;
- (b) be so placed on the package that it is not covered or obscured by any part or attachment to the packaging or any other label or marking; and
- (c) be displayed next to each other when more than one label is required.

Where a package is of such an irregular shape or small size that a label cannot be satisfactorily affixed, the label may be attached to the package by a securely affixed tag or other suitable means.

5.2.2.1.7 Intermediate bulk containers of more than 450 litres capacity and large packagings shall be labelled on two opposite sides.

5.2.2.1.8 *(Reserved)*

5.2.2.1.9 *Special provisions for the labelling of self-reactive substances and organic peroxides*

- (a) The label conforming to model No. 4.1 also implies that the product may be flammable and hence no label conforming to model No. 3 is required. In addition, a label conforming to model No. 1 shall be applied for self-reactive substances Type B, unless the competent authority has permitted this label to be dispensed with for a specific packaging because test data have proven that the self-reactive substance in such a packaging does not exhibit explosive behaviour.
- (b) The label conforming to model No. 5.2 also implies that the product may be flammable and hence no label conforming to model No. 3 is required. In addition, the following labels shall be applied:
  - (i) A label conforming to model No. 1 for organic peroxides type B, unless the competent authority has permitted this label to be dispensed with for a specific packaging because test data have proven that the organic peroxide in such a packaging does not exhibit explosive behaviour;
  - (ii) A label conforming to model No. 8 is required when Packing Group I or II criteria of Class 8 are met.

For self-reactive substances and organic peroxides mentioned by name, the labels to be affixed are indicated in the list found in 2.2.41.4 and 2.2.52.4 respectively.

5.2.2.1.10 *Special provisions for the labelling of infectious substances packages*

In addition to the label conforming to model No. 6.2, infectious substances packages shall bear any other label required by the nature of the contents.

5.2.2.1.11 *Special provisions for the labelling of radioactive material*

5.2.2.1.11.1 Except as provided for large containers and tanks in accordance with 5.3.1.1.3, each package, overpack and container containing radioactive material shall bear at least two labels which conform to the models Nos. 7A, 7B, and 7C as appropriate according to the category (see 2.2.7.8.4) of that package, overpack or container. Labels shall be affixed to two opposite sides on the outside of the package or on the outside of all four sides of the container. Each overpack containing radioactive material shall bear at least two labels on opposite sides of the outside of the overpack. In addition, each package, overpack and container containing fissile material, other than fissile material excepted under 6.4.11.2 shall bear labels which conform to model No. 7E; such labels, where applicable shall be affixed adjacent to the labels for radioactive material. Labels shall not cover the markings specified in 5.2.1. Any labels which do not relate to the contents shall be removed or covered.

- 5.2.2.1.11.2 Each label conforming to models Nos.7A, 7B, and 7C shall be completed with the following information.
- (a) *Contents:*
    - (i) except for LSA-I material, the name(s) of the radionuclide(s) as taken from Table 2.2.7.7.2.1, using the symbols prescribed therein. For mixtures of radionuclides, the most restrictive nuclides shall be listed to the extent the space on the line permits. The group of LSA or SCO shall be shown following the name(s) of the radionuclide(s). The terms "LSA-II", "LSA-III", "SCO-I" and "SCO-II" shall be used for this purpose;
    - (ii) for LSA-I material, only the term "LSA-I" is necessary; the name of the radionuclide is not necessary;
  - (b) *Activity:* The maximum activity of the radioactive contents during carriage expressed in becquerels (Bq) with the appropriate SI prefix symbol (see 1.2.2.1). For fissile material, the mass of fissile material in grams (g), or multiples thereof, may be used in place of activity;
  - (c) For overpacks and containers the "contents" and "activity" entries on the label shall bear the information required in (a) and (b) above, respectively, totalled together for the entire contents of the overpack or container except that on labels for overpacks or containers containing mixed loads of packages containing different radionuclides, such entries may read "See Transport Documents";
  - (d) *Transport index:* see 2.2.7.6.1.1 and 2.2.7.6.1.2 (no transport index entry is required for category I-WHITE).
- 5.2.2.1.11.3 Each label conforming to the model No. 7E shall be completed with the criticality safety index (CSI) as stated in the certificate of approval for special arrangement or the certificate of approval for the package design issued by the competent authority.
- 5.2.2.1.11.4 For overpacks and containers, the criticality safety index (CSI) on the label shall bear the information required in 5.2.2.1.11.3 totalled together for the fissile contents of the overpack or container.
- 5.2.2.1.11.5 In case of international carriage of packages requiring competent authority design or shipment approval, for which different approval types apply in the different countries concerned, labelling shall be in accordance with the certificate of the country of origin of design.
- 5.2.2.2 Provisions for labels**
- 5.2.2.2.1 Labels shall satisfy the provisions below and conform, in terms of colour, symbols and general format, to the models shown in 5.2.2.2.2.
- NOTE: Where appropriate, labels in 5.2.2.2.2 are shown with a dotted outer boundary as provided for in 5.2.2.2.1.1. This is not required when the label is applied on a background of contrasting colour.*
- 5.2.2.2.1.1 Labels shall be in the form of a square set at an angle of 45° (diamond-shaped) with minimum dimensions of 100 mm by 100 mm. They have a line of the same colour as the symbol, 5 mm inside the edge and running parallel with it. Labels shall be displayed on a background of contrasting colour, or shall have either a dotted or solid outer boundary line.



If the size of the package so requires, the dimensions of the labels may be reduced, provided that they remain clearly visible.

5.2.2.2.1.2 Cylinders for Class 2 may, on account of their shape, orientation and securing mechanisms for carriage, bear labels representative of those specified in this section, which have been reduced in size, according to the dimensions outlined in ISO 7225:1994, "Gas cylinders - Precautionary labels", for display on the non-cylindrical part (shoulder) of such cylinders.

Notwithstanding the provisions of 5.2.2.1.6, labels may overlap to the extent provided for by ISO 7225. However, in all cases, the primary risk label and the figures appearing on any label shall remain fully visible and the symbols recognizable.

Empty uncleaned pressure receptacles for gases of Class 2 may be carried with obsolete or damaged labels for the purposes of refilling or inspection as appropriate and the application of a new label in conformity with current regulations or for the disposal of the pressure receptacle.

5.2.2.2.1.3 Labels are divided into halves. With the exception of Divisions 1.4, 1.5 and 1.6, the upper half of the label is reserved for the pictorial symbol and the lower half for texts and the class number and the compatibility group letter as appropriate.

***NOTE:** For the labels of Classes 1, 2, 3, 5.1, 5.2, 7, 8 and 9, the respective class number shall be shown in the bottom corner. For the labels of Classes 4.1, 4.2 and 4.3 and of Classes 6.1 and 6.2 only figures 4 and 6 respectively shall be shown in the bottom corner (see 5.2.2.2.2).*

5.2.2.2.1.4 Except for Divisions 1.4, 1.5 and 1.6, labels for Class 1 show in the lower half the division number and compatibility group letter for the substance or article. Labels for Divisions 1.4, 1.5 and 1.6 show in the upper half the division number and in the lower half the compatibility group letter.

5.2.2.2.1.5 On labels other than those for material of Class 7, the optional insertion of any text (other than the class number) in the space below the symbol shall be confined to particulars indicating the nature of the risk and precautions to be taken in handling.

5.2.2.2.1.6 The symbols, text and numbers shall be clearly legible and indelible and shall be shown in black on all labels except for:

- (a) the Class 8 label, where the text (if any) and class number shall appear in white;
- (b) labels with entirely green, red or blue backgrounds where they may be shown in white; and
- (c) labels conforming to model No. 2.1 displayed on cylinders and gas cartridges for gases of UN Nos. 1011, 1075, 1965 and 1978, where they may be shown in the background colour of the receptacle if adequate contrast is provided.

5.2.2.2.1.7 All labels shall be able to withstand open weather exposure without a substantial reduction in effectiveness.

5.2.2.2.2 Specimen labels

**CLASS 1 HAZARD**  
**Explosive substances or articles**



(No. 1)  
Divisions 1.1, 1.2 and 1.3

Symbol (exploding bomb): black; Background: orange; Figure '1' in bottom corner



(No. 1.4)  
Division 1.4



(No. 1.5)  
Division 1.5



(No. 1.6)  
Division 1.6

Background: orange; Figures: black; Numerals shall be about 30 mm in height and be about 5 mm thick (for a label measuring 100 mm x 100 mm); Figure '1' in bottom corner

- \*\* Place for division - to be left blank if explosive is the subsidiary risk
- \* Place for compatibility group - to be left blank if explosive is the subsidiary risk

**CLASS 2 HAZARD**  
**Gases**



(No. 2.1)  
Flammable gases

Symbol (flame): black or white;  
(except as provided for in 5.2.2.2.1.6 (c))  
Background: red; Figure '2' in bottom corner

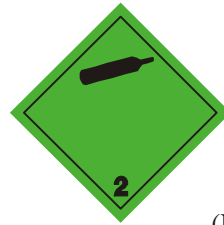

(No. 2.2)

Non flammable, non-toxic gases  
Symbol (gas cylinder): black or white;  
Background: green; Figure '2' in bottom corner



**CLASS 3 HAZARD**  
**Flammable liquids**



(No. 2.3)  
Toxic gases

Symbol (skull and crossbones): black;  
Background: white; Figure '2' in bottom corner



(No. 3)

Symbol (flame): black or white;  
Background: red; Figure '3' in bottom corner

**CLASS 4.1 HAZARD**  
**Flammable solids, self-reactive substances and desensitized explosives**



(No. 4.1)  
 Symbol (flame): black;  
 Background: white with seven vertical red stripes;  
 Figure '4' in bottom corner

**CLASS 4.2 HAZARD**  
**Substances liable to spontaneous combustion**



(No. 4.2)  
 Symbol (flame): black;  
 Background: upper half white, lower half red;  
 Figure '4' in bottom corner

**CLASS 4.3 HAZARD**  
**Substances which, in contact with water, emit flammable gases**



(No. 4.3)  
 Symbol (flame): black or white;  
 Background: blue;  
 Figure '4' in bottom corner



**CLASS 5.1 HAZARD**  
**Oxidizing substances**



(No. 5.1)  
 Symbol (flame over circle): black;  
 Background: yellow;  
 Figure '5.1' in bottom corner

**CLASS 5.2 HAZARD**  
**Organic peroxides**



(No. 5.2)  
 Symbol (flame): black or white;  
 Background: upper half red; lower half yellow;  
 Figure '5.2' in bottom corner



**CLASS 6.1 HAZARD**  
**Toxic substances**



(No. 6.1)  
 Symbol (skull and crossbones): black;  
 Background: white; Figure '6' in bottom corner

**CLASS 6.2 HAZARD**  
**Infectious substances**



(No. 6.2)  
 The lower half of the label may bear the inscriptions: 'INFECTIOUS SUBSTANCE' and 'In the case of damage or leakage immediately notify Public Health Authority';  
 Symbol (three crescents superimposed on a circle) and inscriptions: black;  
 Background: white; Figure '6' in bottom corner

**CLASS 7 HAZARD**  
**Radioactive material**



(No. 7A)

Category I - White  
 Symbol (trefoil): black;  
 Background: white;

Text (mandatory): black in lower half of label:

'RADIOACTIVE'  
 'CONTENTS .....'  
 'ACTIVITY .....'

One red bar shall follow the word 'RADIOACTIVE';  
 Figure '7' in bottom corner.



(No. 7B)

Category II - Yellow

Symbol (trefoil): black;

Background: upper half yellow with white border, lower half white;

Text (mandatory): black in lower half of label:

'RADIOACTIVE'  
 'CONTENTS .....'  
 'ACTIVITY .....'

In a black outlined box: 'TRANSPORT INDEX';  
 Two red vertical bars shall follow the word 'RADIOACTIVE';

Figure '7' in bottom corner.



(No. 7C)

Category III - Yellow

Symbol (trefoil): black;

Background: upper half yellow with white border, lower half white;

Text (mandatory): black in lower half of label:

'RADIOACTIVE'  
 'CONTENTS .....'  
 'ACTIVITY .....'

In a black outlined box: 'TRANSPORT INDEX';  
 Three red vertical bars shall follow the word 'RADIOACTIVE';

Figure '7' in bottom corner.

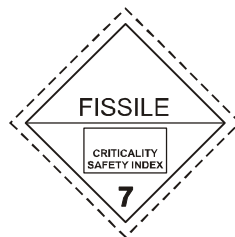

(No. 7E)

Class 7 fissile material

Background: white;

Text (mandatory): black in upper half of label: 'FISSILE';

In a black outlined box in the lower half of the label:

'CRITICALITY SAFETY INDEX'

Figure '7' in bottom corner.

**CLASS 8 HAZARD**  
**Corrosive substances**

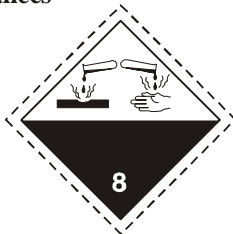

(No. 8)

Symbol (liquids, spilling from two glass vessels and attacking a hand and a metal): black;

Background: upper half white;

lower half black with white border;

Figure '8' in bottom corner

**CLASS 9 HAZARD**

**Miscellaneous dangerous substances and articles**

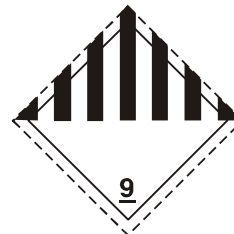

(No. 9)

Symbol (seven vertical stripes in upper half): black;

Background: white;

Figure '9' underlined in bottom corner

## CHAPTER 5.3

### PLACARDING AND MARKING OF CONTAINERS, MEGCs, TANK-CONTAINERS, PORTABLE TANKS AND VEHICLES

**NOTE:** *For marking and placarding of containers, MEGCs, tank-containers and portable tanks for carriage in a transport chain including a maritime journey, see also 1.1.4.2.1. If the provisions of 1.1.4.2.1 (c) are applied, only 5.3.1.3 and 5.3.2.1.1 of this Chapter are applicable.*

#### 5.3.1 Placarding

##### 5.3.1.1 General provisions

5.3.1.1.1 As and when required in this section, placards shall be affixed to the exterior surface of containers, MEGCs, tank-containers, portable tanks and vehicles. Placards shall correspond to the labels required in Column (5) and, where appropriate, Column (6) of Table A of Chapter 3.2 for the dangerous goods contained in the container, MEGC, tank-container, portable tank or vehicle and shall conform to the specifications given in 5.3.1.7. Placards shall be displayed on a background of contrasting colour, or shall have either a dotted or solid outer boundary line.

5.3.1.1.2 For Class 1, compatibility groups shall not be indicated on placards if the vehicle or container is carrying substances or articles belonging to two or more compatibility groups. Vehicles or containers carrying substances or articles of different divisions shall bear only placards conforming to the model of the most dangerous division in the order:

1.1 (most dangerous), 1.5, 1.2, 1.3, 1.6, 1.4 (least dangerous).

When 1.5 D substances are carried with substances or articles of Division 1.2, the vehicle or container shall be placarded as Division 1.1.

Placards are not required for the carriage of explosives of Division 1.4, compatibility group S.

5.3.1.1.3 For Class 7, the primary risk placard shall conform to model No. 7D as specified in 5.3.1.7.2. This placard is not required for vehicles or containers carrying excepted packages and for small containers.

Where both Class 7 labels and placards would be required to be affixed to vehicles, containers, MEGCs, tank-containers or portable tanks, an enlarged label corresponding to the label required may be displayed instead of placard No.7D to serve both purposes.

5.3.1.1.4 Containers, MEGCs, tank-containers, portable tanks or vehicles containing goods of more than one class need not bear a subsidiary risk placard if the hazard represented by that placard is already indicated by a primary or subsidiary risk placard.

5.3.1.1.5 Placards which do not relate to the dangerous goods being carried, or residues thereof, shall be removed or covered.

##### 5.3.1.2 *Placarding of containers, MEGCs, tank-containers and portable tanks*

**NOTE:** *This sub-section does not apply to swap-bodies, except tank swap bodies or swap-bodies carried in combined road/rail transport.*

The placards shall be affixed to both sides and at each end of the container, MEGC, tank-container or portable tank.

When the tank-container or portable tank has multiple compartments and carries two or more dangerous goods, the appropriate placards shall be displayed along each side at the position of the relevant compartments and one placard of each model shown on each side at both ends.

#### **5.3.1.3 *Placarding of vehicles carrying containers, MEGCs, tank-containers or portable tanks***

*NOTE: This sub-section does not apply to the placarding of vehicles carrying swap-bodies other than tank swap-bodies or than swap-bodies carried in combined road/rail transport; for such vehicles, see 5.3.1.5.*

If the placards affixed to the containers, MEGCs, tank-containers or portable tanks are not visible from outside the carrying vehicles, the same placards shall also be affixed to both sides and at the rear of the vehicle. Otherwise, no placard need be affixed on the carrying vehicle.

#### **5.3.1.4 *Placarding of vehicles for carriage in bulk, tank-vehicles, battery vehicles and vehicles with demountable tanks***

Placards shall be affixed to both sides and at the rear of the vehicle.

When the tank-vehicle or the demountable tank carried on the vehicle has multiple compartments and carries two or more dangerous goods, the appropriate placards shall be displayed along each side at the position of the relevant compartments and one placard of each model shown on each side at the rear of the vehicle. However, in such case, if all compartments have to bear the same placards, these placards need be displayed only once along each side and at the rear of the vehicle.

Where more than one placard is required for the same compartment, these placards shall be displayed adjacent to each other.

*NOTE: When, in the course of an ADR journey or at the end of an ADR journey, a tank semi-trailer is separated from its tractor to be loaded on board a ship or an inland navigation vessel, placards shall also be displayed at the front of the semi-trailer.*

#### **5.3.1.5 *Placarding of vehicles carrying packages only***

*NOTE: This sub-section applies also to vehicles carrying swap-bodies loaded with packages, except for combined road/rail transport; for combined road/rail transport, see 5.3.1.2 and 5.3.1.3.*

5.3.1.5.1 For vehicles carrying packages containing substances or articles of Class 1 (other than of Division 1.4, compatibility group S), placards shall be affixed to both sides and at the rear of the vehicle.

5.3.1.5.2 For vehicles carrying radioactive material of Class 7 in packagings or IBCs (other than excepted packages), placards shall be affixed to both sides and at the rear of the vehicle.

#### **5.3.1.6 *Placarding of empty tank-vehicles, battery-vehicles, MEGCs, tank-containers, portable tanks and empty vehicles and containers for carriage in bulk***

5.3.1.6.1 Empty tank-vehicles, vehicles with demountable tanks, battery-vehicles, MEGCs, tank-containers and portable tanks uncleaned and not degassed, and empty vehicles and

containers for carriage in bulk, uncleaned, shall continue to display the placards required for the previous load.

### 5.3.1.7 *Specifications for placards*

5.3.1.7.1 Except as provided in 5.3.1.7.2 for the Class 7 placard, a placard shall:

- (a) Be not less than 250 mm by 250 mm, with a line of the same colour as the symbol running 12.5 mm inside the edge and parallel with it;
- (b) Correspond to the label required for the dangerous goods in question with respect to colour and symbol (see 5.2.2.2); and
- (c) Display the numbers (and for goods of Class 1, the compatibility group letter) prescribed for the dangerous goods in question in 5.2.2.2 for the corresponding label, in digits not less than 25 mm high.

5.3.1.7.2 The Class 7 placard shall be not less than 250 mm by 250 mm with a black line running 5 mm inside the edge and parallel with it and is otherwise as shown below (Model No. 7D). The number "7" shall not be less than 25 mm high. The background colour of the upper half of the placard shall be yellow and of the lower half white, the colour of the trefoil and the printing shall be black. The use of the word "RADIOACTIVE" in the bottom half is optional to allow the use of this placard to display the appropriate UN number for the consignment.

Placard for radioactive material of Class 7

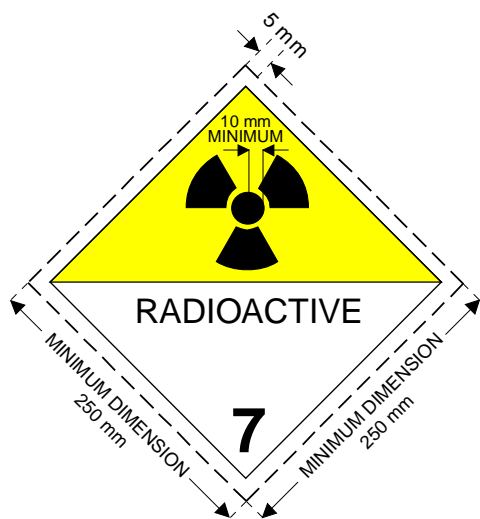

(No.7D)

Symbol (trefoil): black; Background: upper half yellow with white border, lower half white;

The lower half shall show the word "RADIOACTIVE" or alternatively, when required, the appropriate UN Number (see 5.3.2.1.2) and the figure "7" in the bottom corner.

5.3.1.7.3 For tanks with a capacity of not more than 3 m<sup>3</sup> and for small containers, placards may be replaced by labels conforming to 5.2.2.2.

5.3.1.7.4 For Classes 1 and 7, if the size and construction of the vehicle are such that the available surface area is insufficient to affix the prescribed placards, their dimensions may be reduced to 100 mm on each side.

## **5.3.2 Orange-coloured plate marking**

### **5.3.2.1 *General orange-coloured plate marking provisions***

5.3.2.1.1 Transport units carrying dangerous goods shall display two rectangular orange-coloured plates conforming to 5.3.2.2.1, set in a vertical plane. They shall be affixed one at the front and the other at the rear of the transport unit, both perpendicular to the longitudinal axis of the transport unit. They shall be clearly visible.

5.3.2.1.2 When a hazard identification number is indicated in Column (20) of table A of Chapter 3.2, tank-vehicles, battery vehicles or transport units having one or more tanks carrying dangerous goods shall in addition display on the sides of each tank, each tank compartment or each element of battery vehicles, clearly visible and parallel to the longitudinal axis of the vehicle, orange-coloured plates identical with those prescribed in 5.3.2.1.1. These orange-coloured plates shall bear the hazard identification number and the UN number prescribed respectively in Columns (20) and (1) of table A of Chapter 3.2 for each of the substances carried in the tank, in a compartment of the tank or in an element of a battery vehicle.

5.3.2.1.3 For tank-vehicles or transport units having one or more tanks carrying substances with UN Nos. 1202, 1203 or 1223, or aviation fuel classed under UN Nos. 1268 or 1863, but no other dangerous substance, the orange-coloured plates prescribed in 5.3.2.1.2 need not be affixed if the plates affixed to the front and rear in accordance with 5.3.2.1.1 bear the hazard identification number and the UN number prescribed for the most hazardous substance carried, i.e. the substance with the lowest flash-point.

5.3.2.1.4 When a hazard identification number is indicated in Column (20) of Table A of Chapter 3.2, transport units and containers carrying dangerous solid substances in bulk or packaged radioactive material with a single UN number under exclusive use and no other dangerous goods shall in addition display on the sides of each transport unit or container, clearly visible and parallel to the longitudinal axis of the vehicle, orange-coloured plates identical with those prescribed in 5.3.2.1.1. These orange-coloured plates shall bear the hazard identification number and the UN number prescribed respectively in Columns (20) and (1) of table A of Chapter 3.2 for each of the substances carried in bulk in the transport unit or in the container or for the packaged radioactive material carried under exclusive use in the transport unit or in the container.

5.3.2.1.5 If the orange-coloured plates prescribed in 5.3.2.1.2 and 5.3.2.1.4 affixed to the containers, tank-containers, MEGCs or portable tanks are not clearly visible from outside the carrying vehicle, the same plates shall also be affixed to both sides of the vehicle.

5.3.2.1.6 For transport units carrying only one substance, the orange-coloured plates prescribed in 5.3.2.1.2, 5.3.2.1.4 and 5.3.2.1.5 shall not be necessary provided that those displayed at the front and rear in accordance with 5.3.2.1.1 bear the hazard identification number and the UN number prescribed respectively in Columns (20) and (1) of Table A of Chapter 3.2.

5.3.2.1.7 The requirements of 5.3.2.1.1 to 5.3.2.1.5 are also applicable to empty fixed or demountable tanks, battery-vehicles, tank-containers, portable tanks and MEGCs, uncleaned, not degassed or not decontaminated as well as to empty vehicles and containers for carriage in bulk, uncleaned or not decontaminated.



5.3.2.1.8 Orange-coloured marking which does not relate to dangerous goods carried, or residues thereof, shall be removed or covered. If plates are covered, the covering shall be total and remain effective after 15 minute' engulfment in fire.

### 5.3.2.2 *Specifications for the orange-coloured plates*

5.3.2.2.1 The orange-coloured plates shall be reflectorized and shall be of 40 cm base and of 30 cm high; they shall have a black border of 15 mm wide. The material used shall be weather-resistant and ensure durable marking. The plate shall not become detached from its mount in the event of 15 minutes' engulfment in fire. The orange-coloured plates may be separated in their middle with a black horizontal line of 15 mm thickness. If the size and construction of the vehicle are such that the available surface area is insufficient to affix these orange-coloured plates, their dimensions may be reduced to 300 mm for the base, 120 mm for the height and 10 mm for the black border.

For containers carrying dangerous solid substances in bulk and for tank-containers, MEGCs and portable tanks, the plates prescribed in 5.3.2.1.2, 5.3.2.1.4 and 5.3.2.1.5 may be replaced by a self-adhesive sheet, by paint or by any other equivalent process.

This alternative marking shall conform to the specifications set in this sub-section except for the provisions concerning resistance to fire mentioned in 5.3.2.2.1 and 5.3.2.2.2.

**NOTE:** *The colour of the orange plates in conditions of normal use should have chromaticity co-ordinates lying within the area on the chromaticity diagram formed by joining the following co-ordinates:*

<i>Chromaticity co-ordinates of points at the corners of the area on the chromaticity diagram</i>				
<i>x</i>	0.52	0.52	0.578	0.618
<i>y</i>	0.38	0.40	0.422	0.38

*Luminance factor of reflectorized colour:  $\beta > 0.12$ .*

*Reference centre E, standard illuminant C, normal incidence 45°, viewed at 0°.*

*Co-efficient of reflex luminous intensity at an angle of illumination of 5°, viewed at 0.2°: not less than 20 candelas per lux per m<sup>2</sup>.*

5.3.2.2.2 The hazard identification number and the UN number shall consist of black digits 100 mm high and of 15 mm stroke thickness. The hazard-identification number shall be inscribed in the upper part of the plate and the UN number in the lower part; they shall be separated by a horizontal black line, 15 mm in stroke width, extending from side to side of the plate at mid-height (see 5.3.2.2.3). The hazard identification number and the UN number shall be indelible and shall remain legible after 15 minute' engulfment in fire.

5.3.2.2.3 *Example of orange-coloured plate with hazard identification number and UN number*

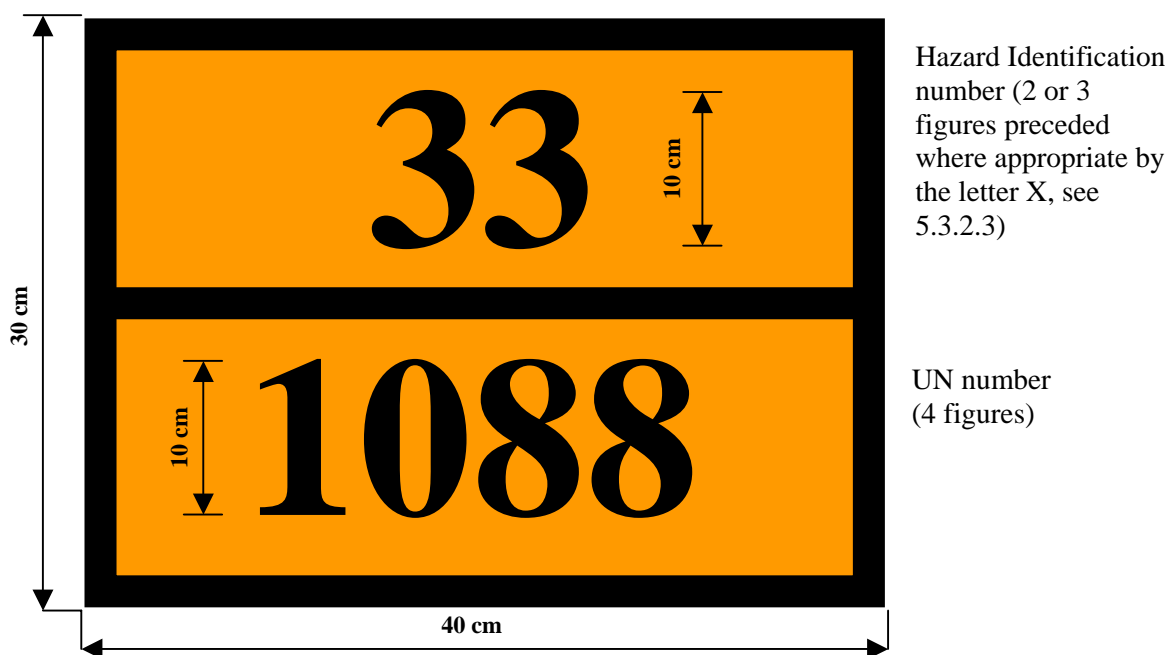

Background orange.  
Border, horizontal line and figures black, 15 mm thickness.

5.3.2.2.4 The permitted tolerances for dimensions specified in this sub-section are  $\pm 10\%$ .

**5.3.2.3** *Meaning of hazard identification numbers*

5.3.2.3.1 The hazard identification number consists of two or three figures. In general, the figures indicate the following hazards:

- 2 Emission of gas due to pressure or to chemical reaction
- 3 Flammability of liquids (vapours) and gases or self-heating liquid
- 4 Flammability of solids or self-heating solid
- 5 Oxidizing (fire-intensifying) effect
- 6 Toxicity or risk of infection
- 7 Radioactivity
- 8 Corrosivity
- 9 Risk of spontaneous violent reaction

**NOTE:** The risk of spontaneous violent reaction within the meaning of figure 9 include the possibility following from the nature of a substance of a risk of explosion, disintegration and polymerization reaction following the release of considerable heat or flammable and/or toxic gases.

Doubling of a figure indicates an intensification of that particular hazard.

Where the hazard associated with a substance can be adequately indicated by a single figure, this is followed by zero.

The following combinations of figures, however, have a special meaning: 22, 323, 333, 362, 382, 423, 44, 446, 462, 482, 539, 606, 623, 642, 823, 842, 90 and 99, see 5.3.2.3.2 below.

If a hazard identification number is prefixed by the letter "X", this indicates that the substance will react dangerously with water. For such substances, water may only be used by approval of experts.

For substances of Class 1, the classification code in accordance with Column (3 b) of Table A of Chapter 3.2, shall be used as the hazard identification number. The classification code consists of:

- the division number in accordance with 2.2.1.1.5; and
- the compatibility group letter in accordance with 2.2.1.1.6.

5.3.2.3.2 The hazard identification numbers listed in Column (20) of table A of Chapter 3.2 have the following meanings:

20	asphyxiant gas or gas with no subsidiary risk
22	refrigerated liquefied gas, asphyxiant
223	refrigerated liquefied gas, flammable
225	refrigerated liquefied gas, oxidizing (fire-intensifying)
23	flammable gas
239	flammable gas, which can spontaneously lead to violent reaction
25	oxidizing (fire-intensifying) gas
26	toxic gas
263	toxic gas, flammable
265	toxic gas, oxidizing (fire-intensifying)
268	toxic gas, corrosive
30	flammable liquid (flash-point between 23 °C and 60 °C, inclusive) or flammable liquid or solid in the molten state with a flash-point above 60 °C, heated to a temperature equal to or above its flash-point, or self-heating liquid
323	flammable liquid which reacts with water, emitting flammable gases
X323	flammable liquid which reacts dangerously with water, emitting flammable gases <sup>1</sup>
33	highly flammable liquid (flash-point below 23 °C)
333	pyrophoric liquid
X333	pyrophoric liquid which reacts dangerously with water <sup>1</sup>
336	highly flammable liquid, toxic
338	highly flammable liquid, corrosive
X338	highly flammable liquid, corrosive, which reacts dangerously with water <sup>1</sup>
339	highly flammable liquid which can spontaneously lead to violent reaction
36	flammable liquid (flash-point between 23 °C and 60 °C, inclusive), slightly toxic, or self-heating liquid, toxic
362	flammable liquid, toxic, which reacts with water, emitting flammable gases
X362	flammable liquid toxic, which reacts dangerously with water, emitting flammable gases <sup>1</sup>
368	flammable liquid, toxic, corrosive
38	flammable liquid (flash-point between 23 °C and 60 °C, inclusive), slightly corrosive or self-heating liquid, corrosive
382	flammable liquid, corrosive, which reacts with water, emitting flammable gases
X382	flammable liquid, corrosive, which reacts dangerously with water, emitting flammable gases <sup>1</sup>
39	flammable liquid, which can spontaneously lead to violent reaction
40	flammable solid, or self-reactive substance, or self-heating substance
423	solid which reacts with water, emitting flammable gases
X423	flammable solid which reacts dangerously with water, emitting flammable gases <sup>1</sup>
43	spontaneously flammable (pyrophoric) solid

<sup>1</sup> Water not to be used except by approval of experts.

44	flammable solid, in the molten state at an elevated temperature
446	flammable solid, toxic, in the molten state, at an elevated temperature
46	flammable or self-heating solid, toxic
462	toxic solid which reacts with water, emitting flammable gases
X462	solid which reacts dangerously with water, emitting toxic gases <sup>1</sup>
48	flammable or self-heating solid, corrosive
482	corrosive solid which reacts with water, emitting flammable gases
X482	solid which reacts dangerously with water, emitting corrosive gases <sup>1</sup>
50	oxidizing (fire-intensifying) substance
539	flammable organic peroxide
55	strongly oxidizing (fire-intensifying) substance
556	strongly oxidizing (fire-intensifying) substance, toxic
558	strongly oxidizing (fire-intensifying) substance, corrosive
559	strongly oxidizing (fire-intensifying) substance, which can spontaneously lead to violent reaction
56	oxidizing substance (fire-intensifying), toxic
568	oxidizing substance (fire-intensifying), toxic, corrosive
58	oxidizing substance (fire-intensifying), corrosive
59	oxidizing substance (fire-intensifying) which can spontaneously lead to violent reaction
60	toxic or slightly toxic substance
606	infectious substance
623	toxic liquid, which reacts with water, emitting flammable gases
63	toxic substance, flammable (flash-point between 23 °C and 60 °C, inclusive)
638	toxic substance, flammable (flash-point between 23 °C and 60 °C, inclusive), corrosive
639	toxic substance, flammable (flash-point not above 60 °C) which can spontaneously lead to violent reaction
64	toxic solid, flammable or self-heating
642	toxic solid, which reacts with water, emitting flammable gases
65	toxic substance, oxidizing (fire-intensifying)
66	highly toxic substance
663	highly toxic substance, flammable (flash-point not above 60 °C)
664	highly toxic solid, flammable or self-heating
665	highly toxic substance, oxidizing (fire-intensifying)
668	highly toxic substance, corrosive
669	highly toxic substance which can spontaneously lead to violent reaction
68	toxic substance, corrosive
69	toxic or slightly toxic substance, which can spontaneously lead to violent reaction
70	radioactive material
78	radioactive material, corrosive
80	corrosive or slightly corrosive substance
X80	corrosive or slightly corrosive substance, which reacts dangerously with water <sup>1</sup>
823	corrosive liquid which reacts with water, emitting flammable gases
83	corrosive or slightly corrosive substance, flammable (flash-point between 23 °C and 60 °C, inclusive)
X83	corrosive or slightly corrosive substance, flammable, (flash-point between 23 °C and 60 °C, inclusive), which reacts dangerously with water <sup>1</sup>

---

<sup>1</sup> Water not to be used except by approval of experts.

839	corrosive or slightly corrosive substance, flammable (flash-point between 23 °C and 60 °C inclusive) which can spontaneously lead to violent reaction
X839	corrosive or slightly corrosive substance, flammable (flash-point between 23 °C and 60 °C inclusive), which can spontaneously lead to violent reaction and which reacts dangerously with water <sup>1</sup>
84	corrosive solid, flammable or self-heating
842	corrosive solid which reacts with water, emitting flammable gases
85	corrosive or slightly corrosive substance, oxidizing (fire-intensifying)
856	corrosive or slightly corrosive substance, oxidizing (fire-intensifying) and toxic
86	corrosive or slightly corrosive substance, toxic
88	highly corrosive substance
X88	highly corrosive substance, which reacts dangerously with water <sup>1</sup>
883	highly corrosive substance, flammable (flash-point between 23 °C and 60 °C inclusive)
884	highly corrosive solid, flammable or self-heating
885	highly corrosive substance, oxidizing (fire-intensifying)
886	highly corrosive substance, toxic
X886	highly corrosive substance, toxic, which reacts dangerously with water <sup>1</sup>
89	corrosive or slightly corrosive substance, which can spontaneously lead to violent reaction
90	environmentally hazardous substance; miscellaneous dangerous substances
99	miscellaneous dangerous substance carried at an elevated temperature.

### 5.3.3 Mark for elevated temperature substances

Tank-vehicles, tank-containers, portable tanks, special vehicles or containers or especially equipped vehicles or containers for which a mark for elevated temperature substances is required according to special provision 580 in Column (6) of Table A of Chapter 3.2 shall bear on both sides and at the rear for vehicles, and on both sides and at each end for containers, tank-containers and portable tanks, a triangular shaped mark with sides of at least 250 mm, to be shown in red, as reproduced below.



<sup>1</sup> Water not to be used except by approval of experts.



## CHAPTER 5.4

### DOCUMENTATION

5.4.0 Any carriage of goods governed by ADR shall be accompanied by the documentation prescribed in this Chapter, as appropriate, unless exempted under 1.1.3.1 to 1.1.3.5.

*NOTE 1: For the list of documentation to be carried on board transport units, see 8.1.2.*

*NOTE 2: The use of electronic data processing (EDP) or electronic data interchange (EDI) techniques as an aid to or instead of paper documentation is permitted, provided that the procedures used for the capture, storage and processing of electronics data meet the legal requirements as regards the evidential value and availability of data during transport in a manner at least equivalent to that of paper documentation.*

#### 5.4.1 Dangerous goods transport document and related information

##### 5.4.1.1 General information required in the transport document

5.4.1.1.1 The transport document(s) shall contain the following information for each dangerous substance, material or article offered for carriage:

- (a) the UN number preceded by the letters "UN";
- (b) the proper shipping name supplemented, when applicable (see 3.1.2.8.1) with the technical name in brackets (see 3.1.2.8.1.1), as determined in accordance with 3.1.2;
- (c) - for substances and articles of Class 1: the classification code given in Column (3b) of Table A in Chapter 3.2.

When, in Column (5) of Table A of Chapter 3.2, label model numbers other than 1, 1.4, 1.5 and 1.6 are given, these label model numbers, in brackets, shall follow the classification code;

- for radioactive material of Class 7: the Class number: "7";

*NOTE: For radioactive material with a subsidiary risk, see also special provision 172 in Chapter 3.3.*

- for substances and articles of other classes: the label model numbers given in Column (5) of Table A in Chapter 3.2 or applicable according to a special provision referred to in Column (6). When more than one label model numbers are given, the numbers following the first one shall be given in brackets. For substances and articles for which no label model is given in Column (5) of Table A in Chapter 3.2, their class according to Column (3a) shall be given instead;
- (d) where assigned, the packing group for the substance which may be preceded by the letters "PG" (e.g. "PG II"), or the initials corresponding to the words "Packing Group" in the languages used according to 5.4.1.4.1;

*NOTE: For radioactive material of Class 7 with subsidiary risks, see special provision 172 (b) in Chapter 3.3.*

- (e) the number and a description of the packages when applicable. UN packaging codes may only be used to supplement the description of the kind of package (e.g. one box (4G));
- (f) the total quantity of each item of dangerous goods bearing a different UN number, proper shipping name or, when applicable, packing group (as a volume or as a gross mass, or as a net mass as appropriate);

*NOTE: In the case of intended application of 1.1.3.6, the total quantity of dangerous goods for each transport category shall be indicated in the transport document in accordance with 1.1.3.6.3.*

- (g) the name and address of the consignor;
- (h) the name and address of the consignee(s). With the agreement of the competent authorities of the countries concerned by the carriage, when dangerous goods are carried to be delivered to multiple consignees who cannot be identified at the start of the carriage, the words "Delivery Sale" may be given instead;
- (i) a declaration as required by the terms of any special agreement.

The location and order in which the elements of information required appear in the transport document is left optional, except that (a), (b), (c) and (d) shall be shown in the order listed above (i.e. (a), (b), (c), (d)) with no information interspersed, except as provided in ADR.

Examples of such permitted dangerous goods descriptions are:

**"UN 1098 ALLYL ALCOHOL, 6.1 (3), I" or  
"UN 1098, ALLYL ALCOHOL, 6.1 (3), PG I"**

5.4.1.1.2 The information required on a transport document shall be legible.

Although upper case is used in Chapter 3.1 and in Table A in Chapter 3.2 to indicate the elements which shall be part of the proper shipping name, and although upper and lower case are used in this Chapter to indicate the information required in the transport document, the use of upper or of lower case for entering the information in the transport document is left optional.

5.4.1.1.3 *Special provisions for wastes*

If waste containing dangerous goods (other than radioactive wastes) is being carried, the UN number and the proper shipping name shall be preceded by the word "**WASTE**", unless this term is part of the proper shipping name, e.g.:

**"WASTE, UN 1230 METHANOL, 3 (6.1), II "**, or  
**"WASTE, UN 1230 METHANOL, 3 (6.1), PG II"**, or  
**"WASTE, UN 1993 FLAMMABLE LIQUID, N.O.S. (toluene and ethyl alcohol), 3, II"**,  
 or  
**"WASTE, UN 1993 FLAMMABLE LIQUID, N.O.S. (toluene and ethyl alcohol), 3, PG II"**

5.4.1.1.4 *Special provisions for dangerous goods packed in limited quantities*

No information is required in the transport document, if any, for carriage of dangerous goods packed in limited quantities according to Chapter 3.4.



5.4.1.1.5 *Special provisions for salvage packagings*

When dangerous goods are carried in a salvage packaging, the words "**SALVAGE PACKAGE**" shall be added after the description of the goods in the transport document.

5.4.1.1.6 *Special provision for empty means of containment, uncleaned*

5.4.1.1.6.1 For empty means of containment, uncleaned, which contain the residue of dangerous goods of classes other than Class 7, the words "EMPTY, UNCLEANED" or "RESIDUE, LAST CONTAINED" shall be indicated before or after the proper shipping name required in 5.4.1.1.1 (b). Moreover, 5.4.1.1.1 (f) does not apply.

5.4.1.1.6.2 The special provision of 5.4.1.1.6.1 may be replaced with the provisions of 5.4.1.1.6.2.1, 5.4.1.1.6.2.2 or 5.4.1.1.6.2.3, as appropriate.

5.4.1.1.6.2.1 For empty packagings, uncleaned, which contain the residue of dangerous goods of classes other than Class 7, including empty uncleaned receptacles for gases with a capacity of not more than 1000 litres, the particulars according to 5.4.1.1.1 (a), (b), (c), (d), (e) and (f) are replaced with "EMPTY PACKAGING", "EMPTY RECEPTACLE", "EMPTY IBC" or "EMPTY LARGE PACKAGING", as appropriate, followed by the information of the goods last loaded, as described in 5.4.1.1.1 (c).

See example as follows: "EMPTY PACKAGING, 6.1 (3)".

In addition, in such a case, if the dangerous goods last loaded are goods of Class 2, the information prescribed in 5.4.1.1.1 (c) may be replaced by the number of the class "2".

5.4.1.1.6.2.2 For empty means of containment other than packagings, uncleaned, which contain the residue of dangerous goods of classes other than Class 7 and for empty uncleaned receptacles for gases with a capacity of more than 1000 litres, the particulars according to 5.4.1.1.1 (a) to (d) are preceded by "EMPTY TANK-VEHICLE", "EMPTY DEMOUNTABLE TANK", "EMPTY TANK-CONTAINER", "EMPTY PORTABLE TANK", "EMPTY BATTERY-VEHICLE", "EMPTY MEGC", "EMPTY VEHICLE", "EMPTY CONTAINER" or "EMPTY RECEPTACLE", as appropriate, followed by the words "LAST LOAD:". Moreover, paragraph 5.4.1.1.1 (f) does not apply.

See examples as follows:

"EMPTY TANK-VEHICLE, LAST LOAD: UN 1098 ALLYL ALCOHOL, 6.1 (3), I" or  
"EMPTY TANK-VEHICLE, LAST LOAD: UN 1098 ALLYL ALCOHOL, 6.1 (3), PG I".

5.4.1.1.6.2.3 When empty means of containment, uncleaned, which contain the residue of dangerous goods of classes other than Class 7, are returned to the consignor, the transport documents prepared for the full-capacity carriage of these goods may also be used. In such cases, the indication of the quantity is to be eliminated (by effacing it, striking it out or any other means) and replaced by the words "EMPTY, UNCLEANED RETURN".

5.4.1.1.6.3 (a) If empty tanks, battery- vehicles and MEGCs, uncleaned, are carried to the nearest place where cleaning or repair can be carried out in accordance with the provisions of 4.3.2.4.3, the following additional entry shall be made in the transport document: "**Carriage in accordance with 4.3.2.4.3**".

(b) If empty vehicles and containers, uncleaned, are carried to the nearest place where cleaning or repair can be carried out in accordance with the provisions of 7.5.8.1, the following additional entry shall be made in the transport document: "**Carriage in accordance with 7.5.8.1**".

- 5.4.1.1.7 *Special provisions for carriage in a transport chain including maritime or air carriage*
- For carriage in accordance with 1.1.4.2.1, a statement shall be included in the transport document, as follows: "**Carriage in accordance with 1.1.4.2.1**".
- 5.4.1.1.8 *(Reserved)*
- 5.4.1.1.9 *(Reserved)*
- 5.4.1.1.10 *Special provisions for exemptions related to quantities carried per transport unit*
- 5.4.1.1.10.1 In the case of exemptions provided for in 1.1.3.6, the transport document shall bear the following inscription: "**Load not exceeding the exemption limits prescribed in 1.1.3.6**".
- 5.4.1.1.10.2 Where consignments from more than one consignor are carried in the same transport unit, the transport documents accompanying these consignments need not bear the inscription mentioned in 5.4.1.1.10.1.
- 5.4.1.1.11 *Special provisions for the carriage of IBCs after the date of expiry of the last periodic test inspection*
- For carriage in accordance with 4.1.2.2, a statement to this effect shall be included in the transport document, as follows: "**Carriage in accordance with 4.1.2.2**".
- 5.4.1.1.12 *(Reserved)*
- 5.4.1.1.13 *Special provisions for carriage in multi-compartment tank-vehicles or transport units with more than one tank*
- When by derogation from 5.3.2.1.2 a multi-compartment tank-vehicle or a transport unit with more than one tank is marked in accordance with 5.3.2.1.3, the substances contained in each tank or in each compartment of a tank shall be specified in the transport document.
- 5.4.1.1.14 *Special provisions for the carriage of substances carried under elevated temperature*
- If the proper shipping name of a substance which is carried or offered for carriage in a liquid state at a temperature equal to or exceeding 100 °C, or in a solid state at a temperature equal to or exceeding 240 °C, does not convey the elevated temperature condition (for example, by using the term "MOLTEN" or "ELEVATED TEMPERATURE" as part of the proper shipping name), the word "**HOT**" shall immediately precede the proper shipping name.
- 5.4.1.1.15 *Special provisions for the carriage of substances stabilized by temperature control*
- If the word "STABILIZED" is part of the proper shipping name (see also 3.1.2.6), when stabilization is by means of temperature control, the control and emergency temperatures (see 2.2.41.1.17) shall be indicated in the transport document, as follows:
- "Control temperature: ....°C Emergency temperature: .... °C"**
- 5.4.1.1.16 *Information required in accordance with special provision 640 in Chapter 3.3*
- Where it is required by special provision 640 of Chapter 3.3, the transport document shall bear the inscription "**Special provision 640X**" where "X" is the capital letter appearing after the pertinent reference to special provision 640 in column (6) of Table A of Chapter 3.2.

5.4.1.1.17 *Special provisions for the carriage of solids in bulk containers conforming to 6.11.4*

When solid substances are carried in bulk containers conforming to 6.11.4, the following statement shall be shown on the transport document (see NOTE at the beginning of 6.11.4):

**"Bulk container BK(x) approved by the competent authority of..."**

**5.4.1.2** *Additional or special information required for certain classes*

5.4.1.2.1 *Special provisions for Class 1*

- (a) The transport document shall indicate, in addition to the requirements in 5.4.1.1.1 (f):
- the total net mass, in kg, of explosive contents <sup>1</sup> for each substance or article bearing a different UN number;
  - the total net mass, in kg, of explosive contents <sup>1</sup> for all substances and articles covered by the transport document;
- (b) For mixed packing of two different goods, the description of the goods in the transport document shall include the UN numbers and names printed in capitals in Columns (1) and (2) of Table A of Chapter 3.2 of both substances or articles. If more than two different goods are contained in the same package in conformity with the mixed packing provisions given in 4.1.10 special provisions MP1, MP2 and MP20 to MP24, the transport document shall indicate under the description of the goods the UN numbers of all the substances and articles contained in the package, in the form, **"Goods of UN Nos..."**;
- (c) For the carriage of substances and articles assigned to an n.o.s. entry or the entry "0190 SAMPLES, EXPLOSIVE" or packed conforming to packing instruction P101 of 4.1.4.1, a copy of the competent authority approval with the conditions of carriage shall be attached to the transport document. It shall be drafted in an official language of the forwarding country and also, if that language is not English, French or German, in English, French or German unless agreements, if any, concluded between the countries concerned in the transport operation provide otherwise;
- (d) If packages containing substances and articles of compatibility groups B and D are loaded together in the same vehicle in accordance with the requirements of 7.5.2.2, a copy of the competent authority approval of the protective compartment or containment system in accordance with 7.5.2.2, note <sup>a</sup> under the table, shall be attached to the transport document. It shall be drafted in an official language of the forwarding country and also, if that language is not English, French or German, in English, French or German unless agreements, if any, concluded between the countries concerned in the transport operation provide otherwise;
- (e) When explosive substances or articles are carried in packagings conforming to packing instruction P101, the transport document shall bear the inscription **"Packaging approved by the competent authority of ..."** (see 4.1.4.1, packing instruction P101);
- (f) *(Reserved)*
- (g) When fireworks of UN Nos. 0333, 0334, 0335, 0336 and 0337 are carried, the transport document shall bear the inscription: **"Classification recognized by the competent authority of ..."** (State referred to in special provision 645 of 3.3.1).

---

<sup>1</sup> For articles, "explosive contents" means the explosive substance contained in the article.

**NOTE:** *The commercial or technical name of the goods may be entered additionally to the proper shipping name in the transport document.*

5.4.1.2.2 *Additional provisions for Class 2*

- (a) For the carriage of mixtures (see 2.2.2.1.1) in tanks (demountable tanks, fixed tanks, portable tanks, tank-containers or elements of battery-vehicles or of MEGCs), the composition of the mixture as a percentage of the volume or as a percentage of the mass shall be given. Constituents below 1% need not be indicated (see also 3.1.2.8.1.2);
- (b) For the carriage of cylinders, tubes, pressure drums, cryogenic receptacles and bundles of cylinders under the conditions of 4.1.6.10, the following entry shall be included in the transport document: "**Carriage in accordance with 4.1.6.10**".

5.4.1.2.3 *Additional provisions for self-reactive substances of Class 4.1 and organic peroxides of Class 5.2*

5.4.1.2.3.1 For self-reactive substances of Class 4.1 and for organic peroxides of Class 5.2 that require temperature control during carriage (for self-reactive substances see 2.2.41.1.17; for organic peroxides, see 2.2.52.1.15 to 2.2.52.1.17), the control and emergency temperatures shall be indicated in the transport document, as follows:

**"Control temperature: ... °C    Emergency temperature: ... °C"**.

5.4.1.2.3.2 When for certain self-reactive substances of Class 4.1 and certain organic peroxides of Class 5.2 the competent authority has permitted the label conforming to model No.1 to be dispensed with for a specific packaging (see 5.2.2.1.9), a statement to this effect shall be included in the transport document, as follows:

**"The label conforming to model No. 1 is not required"**.

5.4.1.2.3.3 When organic peroxides and self-reactive substances are carried under conditions where approval is required (for organic peroxides see 2.2.52.1.8, 4.1.7.2.2 and special provision TA2 of 6.8.4; for self-reactive substances see 2.2.41.1.13 and 4.1.7.2.2, a statement to this effect shall be included in the transport document, e.g. "**Carriage in accordance with 2.2.52.1.8**".

A copy of the competent authority approval with the conditions of carriage shall be attached to the transport document. It shall be drafted in an official language of the forwarding country and also, if that language is not English, French or German, in English, French or German unless agreements, if any, concluded between the countries concerned in the transport operation provide otherwise.

5.4.1.2.3.4 When a sample of an organic peroxide (see 2.2.52.1.9) or a self-reactive substance (see 2.2.41.1.15) is carried, a statement to this effect shall be included in the transport document, e.g. "**Carriage in accordance with 2.2.52.1.9**".

5.4.1.2.3.5 When self-reactive substances type G (see Manual of Tests and Criteria, Part II, paragraph 20.4.2 (g)) are carried, the following statement may be given in the transport document: "**Not a self-reactive substance of Class 4.1**".

When organic peroxides type G (see Manual of Tests and Criteria, Part II, paragraph 20.4.3 (g)) are carried, the following statement may be given in the transport document: "**Not a substance of Class 5.2**".

5.4.1.2.4 *Additional provisions for Class 6.2*

In addition to the information concerning the consignee (see 5.4.1.1.1 (h)), the name and telephone number of a responsible person shall be indicated.

5.4.1.2.5 *Additional provisions for Class 7*

5.4.1.2.5.1 The following information shall be inserted in the transport document for each consignment of Class 7 material, as applicable, in the order given and immediately after the information required under 5.4.1.1.1 (a) to (c):

- (a) The name or symbol of each radionuclide or, for mixtures of radionuclides, an appropriate general description or a list of the most restrictive nuclides;
- (b) A description of the physical and chemical form of the material, or a notation that the material is special form radioactive material or low dispersible radioactive material. A generic chemical description is acceptable for chemical form. For radioactive material with a subsidiary risk, see last sentence of special provision 172 of Chapter 3.3;
- (c) The maximum activity of the radioactive contents during carriage expressed in becquerels (Bq) with an appropriate SI prefix symbol (see 1.2.2.1). For fissile material, the mass of fissile material in grams (g), or appropriate multiples thereof, may be used in place of activity;
- (d) The category of the package, i.e. I-WHITE, II-YELLOW, III-YELLOW;
- (e) The transport index (categories II-YELLOW and III-YELLOW only);
- (f) For consignments including fissile material other than consignments excepted under 6.4.11.2, the criticality safety index;
- (g) The identification mark for each competent authority approval certificate (special form radioactive material, low dispersible radioactive material, special arrangement, package design, or shipment) applicable to the consignment;
- (h) For consignments of more than one package, the information required in 5.4.1.1.1 and in (a) to (g) above shall be given for each package. For packages in an overpack, container, or vehicle, a detailed statement of the contents of each package within the overpack, container, or vehicle and, where appropriate, of each overpack, container, or vehicle shall be included. If packages are to be removed from the overpack, container, or vehicle at a point of intermediate unloading, appropriate transport documents shall be made available;
- (i) Where a consignment is required to be shipped under exclusive use, the statement "**EXCLUSIVE USE SHIPMENT**"; and
- (j) For LSA-II and LSA-III substances, SCO-I and SCO-II, the total activity of the consignment as a multiple of  $A_2$ .

5.4.1.2.5.2 The consignor shall provide in the transport documents a statement regarding actions, if any, that are required to be taken by the carrier. The statement shall be in the languages deemed necessary by the carrier or the authorities concerned, and shall include at least the following information:

- (a) Supplementary requirements for loading, stowage, carriage, handling and unloading of the package, overpack or container including any special stowage provisions for the

safe dissipation of heat (see special provision CV33 (3.2) of 7.5.11), or a statement that no such requirements are necessary;

- (b) Restrictions on the mode of carriage or vehicle and any necessary routing instructions;
- (c) Emergency arrangements appropriate to the consignment.

5.4.1.2.5.3 In case of international carriage of packages requiring competent authority design or shipment approval, for which different approval types apply in the different countries concerned, the UN number and proper shipping name required in 5.4.1.1.1 shall be in accordance with the certificate of the country of origin of design.

5.4.1.2.5.4 The applicable competent authority certificates need not necessarily accompany the consignment. The consignor shall make them available to the carrier(s) before loading and unloading.

**5.4.1.3** *(Reserved)*

**5.4.1.4** *Format and language*

5.4.1.4.1 The document containing the information in 5.4.1.1 and 5.4.1.2 may be that already required by other regulations in force for carriage by another mode of carriage. In case of multiple consignees, the name and address of the consignees and the quantities delivered enabling the nature and quantities carried to be evaluated at any time, may be entered in other documents which are to be used or in any other documents made mandatory according to other specific regulations and which shall be on board the vehicle.

The particulars to be entered in the document shall be drafted in an official language of the forwarding country, and also, if that language is not English, French, or German, in English, French or German, unless international road carriage tariffs, if any, or agreements concluded between the countries concerned in the transport operation, provide otherwise.

5.4.1.4.2 If by reason of the size of the load, a consignment cannot be loaded in its entirety on a single transport unit, at least as many separate documents, or copies of the single document, shall be made out as transport units loaded. Furthermore, in all cases, separate transport documents shall be made out for consignments or parts of consignments which may not be loaded together on the same vehicle by reason of the prohibitions set forth in 7.5.2.

The information relative to the hazards of the goods to be carried (as indicated in 5.4.1.1) may be incorporated in, or combined with, an existing transport or cargo handling document. The layout of the information in the document (or the order of transmission of the corresponding data by electronic data processing (EDP) or electronic data interchange (EDI) techniques) shall be as provided in 5.4.1.1.1.

When an existing transport document or cargo handling document cannot be used for the purposes of dangerous goods documentation for multimodal transport, the use of documents corresponding to the example shown in 5.4.4 is considered advisable<sup>2</sup>.

---

<sup>2</sup> *If used, the relevant recommendations of the UN/ECE Working Party on Facilitation of International Trade Procedures may be consulted, in particular Recommendation No.1 (United Nations Lay-out Key for Trade Documents) (ECE/TRADE/137, edition 96.1), Recommendation No.11 (Documentary Aspects of the International Transport of Dangerous Goods) ECE/TRADE/204, edition 96.1) and Recommendation No.22 (Lay-out Key for standard Consignment Instructions) (ECE/TRADE/168, edition 96.1). Refer to the Trade Data Elements Directory, Volume III, Trade Facilitation Recommendations (ECE/TRADE/200) (United Nations publication Sales No.E.96.II.E.13).*

#### 5.4.1.5 *Non-dangerous goods*

When goods mentioned by name in Table A of Chapter 3.2, are not subject to ADR because they are considered as non-dangerous according to Part 2, the consignor may enter in the transport document a statement to that effect, e.g.: "**Not goods of Class ...**"

*NOTE: This provision may be used in particular when the consignor considers that, due to the chemical nature of the goods (e.g. solutions and mixtures) carried or to the fact that such goods are deemed dangerous for other regulatory purposes the consignment might be subject to control during the journey.*

#### 5.4.2 **Container packing certificate**

If the carriage of dangerous goods in a large container precedes a voyage by sea, a container packing certificate conforming to section 5.4.2 of the IMDG Code<sup>3</sup> shall be provided with the transport document<sup>4</sup>.

---

<sup>3</sup> *Guidelines for use in practice and in training for loading goods in transport units have also been drawn up by the International Maritime Organization (IMO), the International Labour Organization (ILO) and the United Nations Economic Commission for Europe (UNECE) and have been published by IMO ("IMO/ILO/UNECE Guidelines for Packing of Cargo Transport Units (CTUs)").*

<sup>4</sup> *Section 5.4.2 of the IMDG Code requires the following:*

##### **"5.4.2 Container/vehicle packing certificate**

*5.4.2.1 When dangerous goods are packed or loaded into any container or vehicle, those responsible for packing the container or vehicle shall provide a "container/vehicle packing certificate" specifying the container/vehicle identification number(s) and certifying that the operation has been carried out in accordance with the following conditions:*

- .1 The container/vehicle was clean, dry and apparently fit to receive the goods;*
- .2 Packages, which need to be segregated in accordance with applicable segregation requirements, have not been packed together onto or in the container/vehicle [unless approved by the competent authority concerned in accordance with 7.2.2.3 (of the IMDG Code)];*
- .3 All packages have been externally inspected for damage, and only sound packages have been loaded;*
- .4 Drums have been stowed in an upright position, unless otherwise authorized by the competent authority, and all goods have been properly loaded, and, where necessary, adequately braced with securing material to suit the mode(s) of transport for the intended journey;*
- .5 Goods loaded in bulk have been evenly distributed within the container/vehicle;*
- .6 For consignments including goods of class 1, other than division 1.4, the container/vehicle is structurally serviceable in conformity with 7.4.6 (of the IMDG Code);*
- .7 The container/vehicle and packages are properly marked, labelled, and placarded, as appropriate;*
- .8 When solid carbon dioxide (CO<sub>2</sub>-dry ice) is used for cooling purposes, the container/vehicle is externally marked or labelled in a conspicuous place, such as, at the door end, with the words: "DANGEROUS CO<sub>2</sub> GAS (DRY ICE) INSIDE. VENTILATE THOROUGHLY BEFORE ENTERING"; and*
- .9 A dangerous goods transport document, as indicated in 5.4.1 (of the IMDG Code) has been received for each dangerous goods consignment loaded in the container/vehicle.*

*NOTE: The container/vehicle packing certificate is not required for tanks*

*5.4.2.2 The information required in the dangerous goods transport document and the container/vehicle packing certificate may be incorporated into a single document; if not, these documents shall be attached one to the other. If the information is incorporated into a single document, the document shall include a signed declaration such as "It is declared that the packing of the goods into the container/vehicle has been carried out in accordance with the applicable provisions". This declaration shall be dated and the person signing this declaration shall be identified on the document."*

The functions of the transport document required under 5.4.1 and of the container packing certificate as provided above may be incorporated into a single document; if not, these documents shall be attached one to the other. If these functions are incorporated into a single document, the inclusion in the transport document of a statement that the loading of the container has been carried out in accordance with the applicable modal regulations together with the identification of the person responsible for the container packing certificate shall be sufficient.

*NOTE: The container packing certificate is not required for portable tanks, tank-containers and MEGCs.*

### **5.4.3 Instructions in writing**

5.4.3.1 As a precaution against any accident or emergency that may occur or arise during carriage, the driver shall be given instructions in writing, specifying concisely for each dangerous substance or article carried or for each group of goods presenting the same dangers to which the substance(s) or article(s) carried belong(s):

- (a) - the name of the substance or article or group of goods;  
- the class; and  
- the UN number, or for a group of goods, the UN numbers;
- (b) the nature of the danger inherent in these goods as well as the measures to be taken by the driver and the personal protection equipment to be used by the driver;
- (c) the general actions to be taken, e.g. to warn the road users and passers-by and call the police/fire brigade;
- (d) the additional actions to be taken to deal with minor leakages or spillages to prevent their escalation, if this can be achieved without personal risk;
- (e) the special actions to be taken for certain goods, if applicable;
- (f) the necessary equipment for additional and/or special actions, if applicable.

5.4.3.2 These instructions shall be provided by the consignor and shall be handed out to the driver at the latest when the dangerous goods are loaded on the vehicle. Information on the content of the instructions shall be supplied to the carrier at the latest when the carriage order is given, so as to enable him to take the necessary steps to ensure that the employees concerned are aware of these instructions and are capable of carrying them out properly and to ensure that the necessary equipment is on board the vehicle.

5.4.3.3 The consignor shall be responsible for the content of these instructions. They shall be provided in a language the driver(s) taking over the dangerous goods is (are) able to read and to understand, and in all languages of the countries of origin, transit and destination. In the case of countries with more than one official language, the competent authority shall specify the official language or languages applicable throughout the territory or in each region or part of the territory.

5.4.3.4 These instructions shall be kept readily identifiable in the driver's cab.

5.4.3.5 Instructions in writing according to this section which are not applicable to the goods which are on board of the vehicle, shall be kept separate from pertinent documents in such a way as to prevent confusion.



- 5.4.3.6 The carrier shall ensure that the drivers concerned understand and are capable of carrying out these instructions properly.
- 5.4.3.7 In case of mixed loads of packaged goods including dangerous goods which belong to different groups of goods presenting the same dangers, the instructions in writing may be restricted to one instruction per class of dangerous goods carried on board of the vehicle. In such case no name of goods, or UN number has to be mentioned in the instructions.
- 5.4.3.8 These instructions shall be drafted according to the following format:

#### **LOAD**

- Mention of the following details concerning the goods for which these instructions are intended or applicable:
  - the name of the substance or article, or group of goods presenting the same dangers;
  - the class; and
  - the UN number or, for a group of goods, the UN numbers.
- Description shall be restricted to e.g. the physical state with indication of any colour and mention of any odour, to aid identification of leakages or spillages.

#### **NATURE OF DANGER**

Short enumeration of dangers:

- Main danger;
- Additional dangers including possible delayed effects and dangers for the environment;
- Behaviour under fire or heating (decomposition, explosion, development of toxic fumes, etc.);
- If applicable, it shall be mentioned here that the goods carried react dangerously with water.

#### **PERSONAL PROTECTION**

Mention of the personal protection intended for the driver in accordance with the requirements of 8.1.5 (b) and (c).

#### **GENERAL ACTIONS TO BE TAKEN BY DRIVER**

Mention of the following instructions:

- Stop the engine;
- No naked lights. No smoking;
- Mark roads and warn other road users or passers-by;
- Inform the public about the hazard and give advice to keep upwind;
- Notify police and fire brigade as soon as possible.

## **ADDITIONAL AND/OR SPECIAL ACTIONS TO BE TAKEN BY THE DRIVER**

Appropriate instructions shall be included here as well as the list of equipment necessary for the driver to perform the additional and/or special actions according to the class(es) of the goods being carried (e.g. shovel, collecting container, etc.).

It is considered that drivers of vehicles should be instructed and trained to take additional actions with minor leakages or spillages to prevent their escalation, provided that this can be achieved without personal risk.

It is considered that any special action recommended by the consignor requires a special training of the driver. If applicable, appropriate instructions shall be included here as well as the list of equipment needed for these special actions.

### **FIRE**

Information for the driver in case of fire:

Drivers should be instructed during training to deal with minor vehicle fires. They shall not attempt to deal with any fire involving the load.

### **FIRST AID**

Information for the driver in case of contact with the carried good(s).

## **ADDITIONAL INFORMATION**

\* \* \* \* \*

### **5.4.4 Example of a multimodal dangerous goods form**

Example of a form which may be used as a combined dangerous goods declaration and container packing certificate for multimodal carriage of dangerous goods.





## CHAPTER 5.5

### SPECIAL PROVISIONS

5.5.1 *(Deleted)*

#### 5.5.2 Special provisions for fumigated vehicles, containers and tanks

5.5.2.1 For the carriage of UN No. 3359 fumigated unit (vehicle, container or tank) the transport document shall show the information required in 5.4.1.1.1, the date of fumigation and the type and amount of the fumigant used. These particulars shall be drafted in an official language of the forwarding country and also, if the language is not English, French or German, in English, French or German, unless agreements, if any, concluded between the countries concerned in the transport operation provide otherwise. In addition, instructions for disposal of any residual fumigant including fumigation devices (if used) shall be provided.

5.5.2.2 A warning sign as specified in 5.5.2.3 shall be placed on each fumigated vehicle, container or tank in a location where it will be easily seen by persons attempting to enter the interior of vehicle, container or tank. The particulars concerning the warning sign shall be drafted in a language considered appropriate by the consignor.

5.5.2.3 The fumigation warning sign shall be rectangular and shall not be less than 300 mm wide and not less than 250 mm high. The markings shall be black print on a white background with lettering not less than 25 mm high. An illustration of this sign is given in the figure below.

#### Fumigation warning sign

